

Float Type Multi-Point Custom Length – 1 to 7 Levels

GEMS Custom Length level switches are extremely versatile. Within this section you'll find level switches that are configured to your custom specifications at the GEMS factory.

Single Actuation Levels

When one of our Standard Single Level switches doesn't extend to the length you need, no problem, order a Custom Length single level switch from this section. Specify lengths to over 11 feet. These units also offer you the flexibility of mounting a low, or intermediate level switch from the tank top rather than a bottom or side mounting.

2 to 7 Levels

GEMS Custom Length models can be configured with "up to seven" independent switch actuation levels, depending on the series type. These "multi-station" units offer the most practical way to monitor multiple liquid level points within a single tank. Only a single entry point into the tank is required, and all electrical wiring emanates from a single source. In addition to tracking changing level points of a single liquid within a tank, "multi-station" level switches are ideal for monitoring liquid interfaces and emulsions in vessels simultaneously containing two or more liquids. Contact GEMS with your liquid specifications for further information on this type of application.

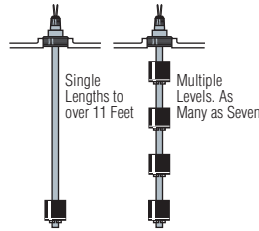

Typical Application

GEMS Custom Length Switches are used to monitor water, diesel or lube oils, chemicals and petrochemicals.

Pump-Up/Pump-Down Operations

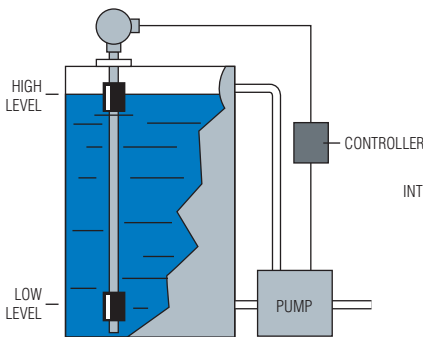

Pump-Up/Pump-Down with Intermediate Level Indication

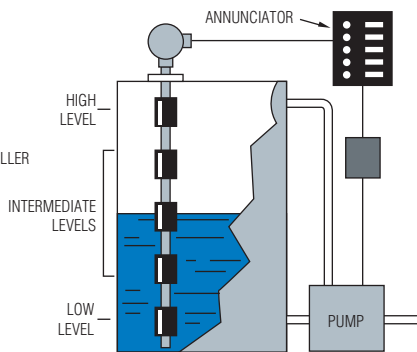

Using GEMS Custom Length level switches, junction boxes, solid-state relays and annunciators, complete liquid level control systems are easily configured.

Liquid Interface Monitoring

In addition to monitoring the surface level of liquids, many GEMS Level Switches can be used to sense the interface point between dissimilar liquids sharing the same tank. Monitoring water condensation in fuel storage tanks, and separating chemical emulsions in process systems are two typical application examples. Multi-station level switches can be configured to monitor this interface point in addition to high and low liquid levels. Contact Gems Sensors Inc. with your specific application.

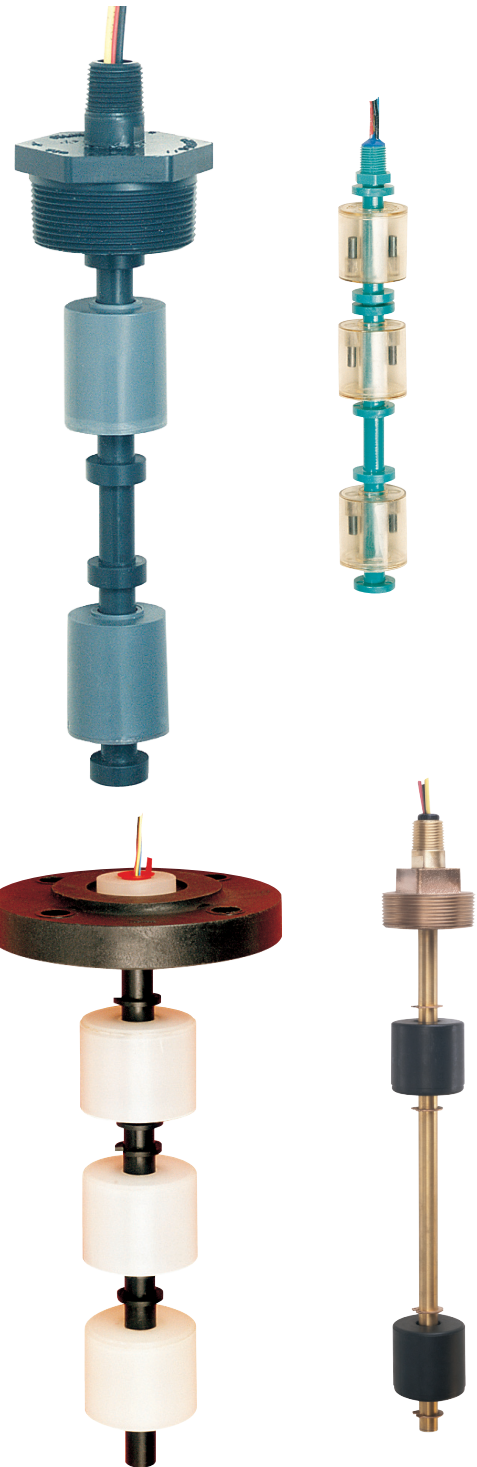
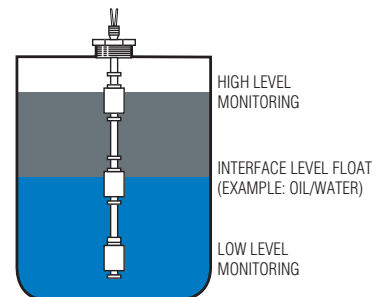

Ultrasonic — Non-Contact Multi-Point Sensors

- ▶ Accurate and reliable sensing method
- ▶ Ideal technology for difficult fluids

Gems delivers the answer for challenging fluid measurement with our new ultrasonic UCL-510 Transmitter/Multipoint Level Switching Combo. This accurate and reliable sensor is designed for the most difficult fluids to monitor — including ultrapure, dirty, coating, scalding or corrosive types.



Typical Media

- Acids • Wastewater • Inks and Paints • Slurries • Food and Beverage
- Semiconductor Process Chemicals • Oils and Petroleum Distillates

How Ultrasonic Monitoring Works

Mounted at the top of a tank, the sensor continuously transmits pulses of high-frequency sound waves that travel away from the sensor, hit the surface of the liquid and return to the sensor. Solid-state electronics measure the time it takes from transmitted sound to return of the echo. With reference to the speed of sound in air, the exact distance of the liquid surface from the sensor can be calculated with high accuracy ($\pm 0.125''$ (3mm) of maximum range). Level/Distance measurements are automatically temperature-compensated throughout the operating temperature range of the sensor.



See the UCL-510 and other Continuous Level Transmitters in Section C.

Contents	Page Start
Small Size Engineered Plastic	
LS-300 Series.....	B-3
LS-300TFE Series	B-7
LS-350 Series.....	B-10
Small Size Alloy	
LS-700 Series.....	B-14
Large Size Plastic	
LS-800PVC Series.....	B-18
LSP-800.....	B-20
Large Size Alloy	
LS-800 Series.....	B-22
Integrated Temperature Sensors	
for LS-700 & LS-800 Series	B-25
OrderIt! Check List	
All LS-800 Series Models	B-26
UCL-510 Ultrasonic Transmitter/Multipoint Switch.....	
	C-19

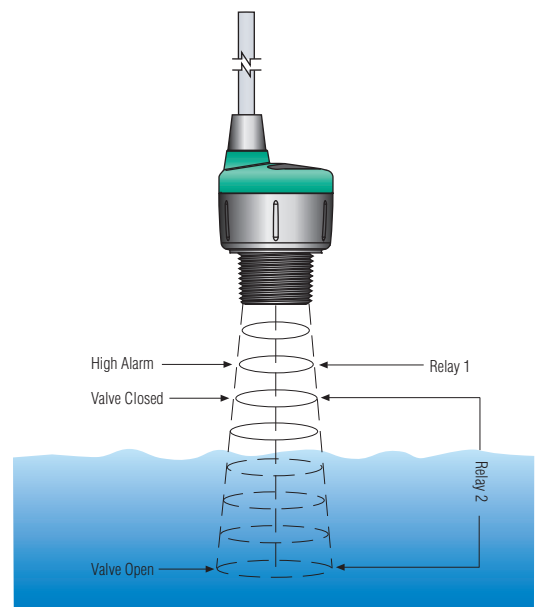

UCL-510 Series multi-point switches are designed for easy automatic tank “Hi/Lo” liquid level control. They combine non-contact continuous sensing with four SPST relays; actuation points are field adjustable in a range to 49 inches.

LEVEL SWITCHES – MULTI POINT

Small Size – Engineered Plastics

LS-300 Engineered Plastics Series

Brings Multi-Point Switching to Shallow Tanks

Your most complete line of small, polysulfone liquid level switches...all from Gems Sensors.

- ▶ All-Plastic Wetted Parts
- ▶ 1 to 4 Actuation Levels
- ▶ Lengths to 20 inches (50cm)
- ▶ U.L. Recognized; CSA Listed Versions Available

Designed for the high quantity needs of the OEM, LS-300 Series Switches are the ideal level sensor for shallow tanks and reservoirs. Compact and versatile, these low-cost, plastic level switches offer a broad choice of mountings and float materials. The following pages illustrate the various design parameters available to configure custom LS-300 Series Switches.

1. Mounting Types

Each mounting type can be configured with stem lengths (L_0) and float materials indicated in this bulletin.



LEVEL SWITCHES – MULTI POINT



NPT Threads		Straight Threads		
Type 21 1/8" NPT	Type 22 1" NPT	Type 31 3/8" - 24	Type 32 1-5/16" - 12	Type 33 5/8" - 11
Metric Threads		Compression Types		
Type 41 G 1/4" (1/4" - 19 BSP)	Type 42 G 1" (1" - 11 BSP)	Type 51 M12 x 1.5 Straight Thread	Type 71' 5/8" - 11	Type 11 No Mounting
Flange Mountings ²				
Type 61 2" O.D. Flange		Type 63 Pop Flange		

Stem, Mounting and Collar Material	Polysulfone, Noryl®
Max Length (L_0)	20 inches (50 cm) Tolerance of $L_0 = \pm 1/16"$ (2 mm)
Mounting Position	Vertical $\pm 30^\circ$ Inclination

Notes:
1. Type 71 mounting to be used with 3/4" diameter float only.
2. Not recommended for pressure applications.

Dimensions expressed as: $\frac{\text{inches}}{\text{millimeters}}$

2. Electrical Connections

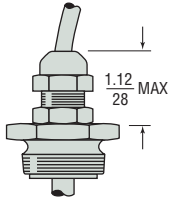
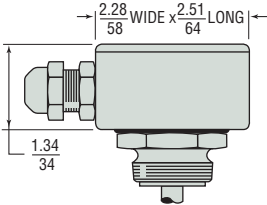
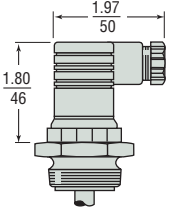
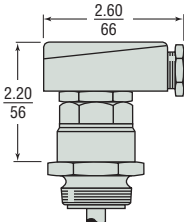
	Type 1 Leadwire	Type 2 Cable	Type 3 Liquid-Tight Cable	Type 4 Junction Box Assembly	Type 5 DIN43650 Plug	Type 6 DIN43651 Plug
						
Compatible Mounting Type(s)	All		42		42	42
Protection Rating	IP64		IP68	IP65		
Extended Leads	#22 AWG PVC Wire, 24" (610mm) Min.	#22 AWG PVC Jacketed Cable, 24" (610mm) Min.		Terminal Box (7 Terminals)	3 Poles	6 Poles
Max. Number of Levels						
Group I			4		2	4
Group II			2		1	2

* Not CSA Approved
 ** Not UL or CSA Listed

3. Float Types

A single float type is selected for use at all actuation points.

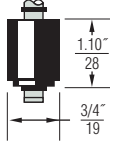
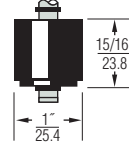
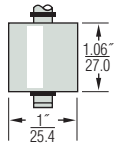
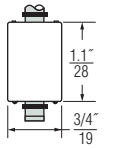
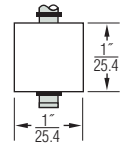
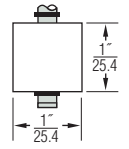
Float Material	Buna N		Polysulfone	Polypropylene		
	3/4"	1"		Solid Foamed		Hollow – 20% Glass Filled
Float Dimensions						
Part Number	187553	39049	39005	197732	119455	145730
Float Material Suitable for...	Oil, Fuels		Water-based Liquids	Broad Chemical Use		Low Specific Gravity Liquids
Operating Temperature ¹	Water: to 180°F (80°C) Oil: to 221°F (105°C)		-40°F to +221°F (-40°C to +105°C)	-40°F to +212°F (-40°C to +100°C)		-40°F to +221°F (-40°C to +105°C)
	Oil: -40°F to +221°F (-40°C to +105°C)					
Pressure, psi (bar) Max. ²	300 (21)	250 (17)	50 (3.5)	Atmospheric	150 (10)	50 (3.5)
Min. Media Specific Gravity	0.70	0.50	0.75	0.95	0.90	0.60

Notes:

- Operating temperature range based on float ratings.
- When used with mounting Type 21, 32 or 22 only; Mounting Type 61, and 63 are not recommended for pressure applications. Pressures are derated with increasing temperature above 70°F

Dimensions expressed as: $\frac{\text{inches}}{\text{millimeters}}$

4. Electrical Specifications

Typically, one float is required for each point at which you need a switch action to occur. The number of actuation levels available depends on the Group Type Wiring selected; see below.

Group I Wiring: 1 to 4 Actuation Levels.

Group II Wiring: 1 or 2 Actuation Levels.

Switch (SPST, N.O. or N.C.): 10/20/50/100 VA.

Approvals: LS-300 Series switches are U.L. Recognized – File No. E45168; CSA Listed – 30200.

Notes:

- Units with 50 and 100 VA switches are not U.L. Recognized or CSA Listed.
- Other wiring options available. Consult factory.
- Consult Factory for load information.

6. Actuation Level Dimensions

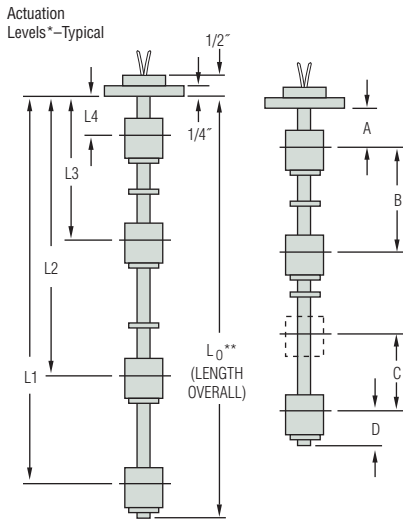

* Actuation level distances and L₀ (overall unit length) are measured from inner surfaces of mounting plug or flange. See mounting types on page 1 for L₀ reference point.
 ** Length Overall (L₀) = L₁ + Dimension D. See Mounting Types for Maximum Length values.

5. Wiring Group

Electrical Connection	Group 1	Group 2
Lead Wire (*)		
Cable (*)		

*Pin correlation of plug connectors shown in parenthesis.

Switch actuation levels are determined following the guidelines below.

A = Minimum distance to highest actuation level.

B = Minimum distance between actuation levels.

C = Minimum distance between two actuation levels with one float (Note: One float for two levels can be used only when low level is N.C. dry and high level is N.O. dry).

D = Minimum distance from end of unit to lowest level.

Float Type	Dimensions			
	A	B	C	D
Buna N – 1" (P/N 39049)	1" (25 mm)	1-3/4" (45 mm)	1/8" (3 mm) Minimum	11/16" (18 mm)
Buna N – 3/4" (P/N 187553)	11/16" (17 mm)	1-7/16" (11.1 mm)		7/8" (22 mm)
Polysulfone (P/N 39005)	7/8" (22 mm)	1-3/4" (45 mm)		15/16" (24 mm)
Solid P.P. – 1" (P/N 119455)	5/8" (16 mm)			1-1/8" (29 mm)
Solid P.P. – 3/4" (P/N 197732)	1/2" (13 mm)	1-1/2" (38 mm)		1.19" (30 mm)
Hollow P.P. – 1" (P/N 145730)	7/8" (22 mm)	1-3/4" (45 mm)		7/8" (22 mm)

Notes:

- Actuation levels are calibrated on ascending fluid level with water, specific gravity 1.0, as the calibrating fluid, unless otherwise specified.
- Tolerance on actuation levels is ±1/8" (3 mm).

FAX IT!
860-747-4244

Photocopy This Form
Use one form for each product type you are selecting.
This form may also be completed online at gemssensors.com for RFQ.

This is a Request for a Quote
 Order P.O.# _____

Quantity Needed _____

Date Required ____/____/____

Shipping Method: _____

Partials Accepted: Yes
 No

Name _____

Company _____

Street _____

City _____ State ____ Zip _____

Phone (____) _____

Fax (____) _____

LS-300 Engineered Plastics Custom Length, Float Type Level Switch Check List

Operational Parameters

This information is essential to the accurate and proper operation of your GEMS configurable sensor. Please complete fully and accurately before ordering.

- 1. Liquid Media:** _____
- 2. Pressure:** Minimum _____ psig bar Maximum _____
- 3. Temperature:** Minimum _____ °F °C Maximum _____ °F °C
- 4. Specific Gravity:** Minimum _____ Maximum _____

- 5. Viscosity:** _____ SSU
- 6. Tank Material:** _____
- Tank Depth:** _____
- 7. Unit is Mounted In:** T – Top Mounted B – Bottom Mounted

Product Parameters

1. Mounting Type:

- 11 – No Mounting 21 – 1/8" NPT
- 22 – 1" NPT 31 – 3/8"-24 Straight Thread
- 32 – 1-5/16"-12 41 – G1/4" (1/4"-19BSP)
- 42 – G1" (1"-11BSP) 51 – M12 x 1.5 Straight Thread
- 61 – 2" O.D. Flange 33 – 5/8"-11
- 63 – Pop Flange 71 – 5/8"-11 with 3/4" floats only

4. Electrical Rating:

- 010 – SPST, 10VA 020 – SPST, 20VA
- 050 – SPST, 50VA 100 – SPST, 100VA

5. Wiring Group:

- Group 1 – Common Return
- Group 2 – Independent Return

2. Electrical Connections:

<input checked="" type="checkbox"/>	Type	Description	Compatible Mountings
	1	Lead Wires, 24" to 26" (610mm, Min.)	All
	2	Cable, 24" to 26" (610mm, Min)	All
	3	Liquid-Tight Cable Fitting	42
	4	Junction Box Assembly	42
	5	DIN43650 Plug Connector, 3 Poles	42
	6	DIN43651 Plug Connector, 6 Poles	42

3. Float Type:

- Buna-N – P/N 39049 Polysulfone – P/N 39005
- Solid Foamed Polypropylene – P/N 119455
- Buna N – P/N 187553 Solid Foamed Polypropylene – P/N 197732
- Hollow Polypropylene – P/N 145730

6. Switch Actuation Level:

Actuation Level	Distance to Actuation Level* <input type="checkbox"/> Inches <input type="checkbox"/> Millimeters	SPST Switch Operation** (Check Type)	
		N.O.	N.C.
L4			
L3			
L2			
L1***			

* Measured from inner surface of mounting plug or flange. See mounting types on page B-3.

** Switch position is "normal" with unit dry (tank empty).

*** L1 is the distance to the lowest actuation level with mounting "up," and is the distance to the highest actuation level with mounting "down."

B. Length Overall _____ Inches Millimeters

Please contact GEMS Sensors Inc. for any configuration or special requirements not covered on this form. **800-378-1600**

Quote \$ _____ Date Quoted ____/____/____



Gems Sensors & Controls
One Cowles Road
Plainville, CT
06062-1198

tel 860.747.3000
fax 860.747.4244
www.gemssensors.com

Small Size – Engineered Plastics

LS-300TFE Series – All-PTFE Wetted Parts for Ultra-Pure Fluids

- ▶ Low Particle Generation-One piece Molded Design
- ▶ Corrosion Resistant
- ▶ 1 to 4 Actuation Levels in a Single Unit
- ▶ Lengths to 24 Inches

Typical Applications



- Semiconductor Process Equipment
- Pure Chemical Delivery System
- Wafer Cleaning and Etching Systems
- Cabinet Leak Sensing

1. Mounting Types

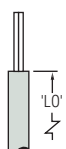
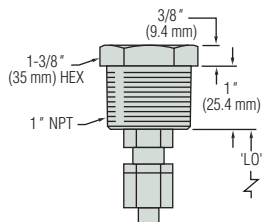
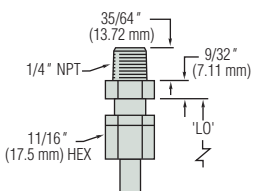
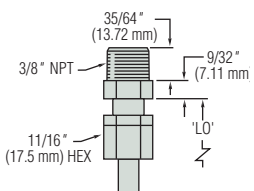
Each mounting type can be configured with stem lengths (L_0) and float materials indicated in this bulletin.

Type 11, No Mounting	Type 22, 1" NPT	Type 24, 1/4" NPT	Type 25, 3/8" NPT
			

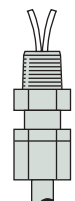
2. Electrical Connections

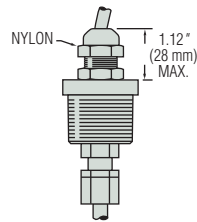
Type 1 Leadwire	Type 2 Cable	Type 3* Liquid-Tight Cable
		
Extended Leads	#22 AWG Teflon® Wire or #24 AWG PVC Jacketed Cable	

* Available on Mounting Type 22 only.

3. Float Types

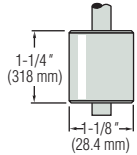
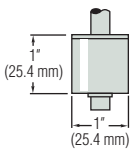
Float Material	PTFE	PVDF
Float Dimensions		
Operating Temperature	+32°F to +212°F (0°C to 100°C)	-40°F to +250°F (-40°C to 121°C)
Pressure, PSIG (bar), Max. at Ambient Temperature	25 (1.7)	50 (3.4)
Min. Liquid Specific Gravity	0.86	0.86

Note: A single float type is selected for use at all actuation points.

ORDER IT!
Ordering is Easy! See Page B-9.
Easy online ordering too!



4. Electrical Specifications

Typically, one float is required for each point at which you need a switch action to occur. The number of actuation levels available depends on the Group Type Wiring selected; see below.

Group I Wiring: 1 to 4 Actuation Levels.

Group II Wiring: 1 or 2 Actuation Levels.

Switch (SPST, N.O. or N.C.): 10/20/50/100VA.

Notes:

1. Other wiring options available. Consult factory.
2. Consult Factory for load information.

Electrical Connection	Group 1	Group 2
Lead Wire (*)		
Cable (*)		

*Pin correlation of plug connectors shown in parenthesis.

5. Actuation Level Dimensions

- * Actuation level distances and L_0 (overall unit length) are measured from inner surface of mounting. See mounting types on opposite page for L_0 reference point.
- ** Length Overall (L_0) = L_1 + Dimension D. $L_{0max.} = 24"$.

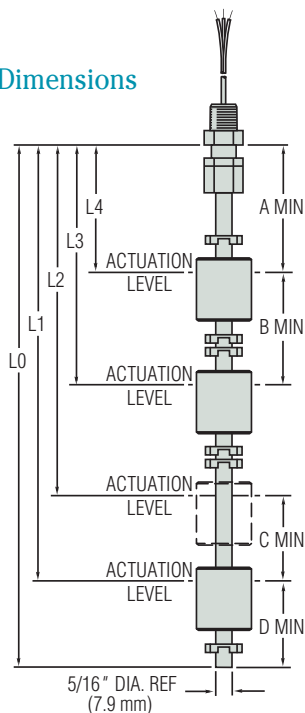

Switch actuation levels are determined following the guidelines below.

A = Minimum distance from highest actuation level to bottom of mounting.

B = Minimum distance between actuation levels.

C = Minimum distance between two actuation levels with one float (Note: One float for two levels can be used only when low level is N.C. dry and high level is N.O. dry).

D = Minimum distance from end of unit to lowest level.

Float Material	Dimensions			
	A	B	C	D
PTFE	$\frac{1-3/4}{44.5^*}$	$\frac{2}{50.8}$	$\frac{1/8}{3.2}$	$\frac{1-1/4}{31.8}$
PVDF	$\frac{1-3/4}{44.5^*}$	$\frac{2}{50.8}$	$\frac{1/8}{3.2}$	$\frac{1-1/8}{28.6}$

inch
mm

*Mounting Type 22 (1" NPT) requires a minimum "A" dim. of 1-3/4" (44.5mm)

<p align="center">FAX IT! 860-747-4244</p> <p align="center">Photocopy This Form</p> <p align="center">Use one form for each product type you are selecting.</p> <p align="center">This form may also be completed online at gemssensors.com for RFQ.</p>	This is a <input type="checkbox"/> Request for a Quote <input type="checkbox"/> Order P.O.# _____	Name _____ Company _____ Street _____ City _____ State ____ Zip _____ Phone (____) _____ Fax (____) _____
	Quantity Needed _____ Date Required ____/____/____ Shipping Method: _____ Partial Accepted: <input type="checkbox"/> Yes <input type="checkbox"/> No	

LS-300TFE Custom Length Level Switches

Application Environmental Conditions

This information is essential to the accurate and proper operation of your GEMS configurable sensors. Please complete fully and accurately.

1. Liquid Media: _____	5. Viscosity: _____ SSU
2. Pressure: Minimum _____ psig Maximum _____	6. Tank Material: _____
3. Temperature: Minimum _____ °F Maximum _____	Tank Depth: _____
4. Specific Gravity: Minimum _____ Maximum _____	7. Unit is Mounted In: <input type="checkbox"/> Tank Top <input type="checkbox"/> Tank Bottom

Product Parameters

1. Mounting Type:

- Type 11 – No Mounting
- Type 22 – 1" NPT
- Type 24 – 1/4" NPT
- Type 25 – 3/8" NPT

2. Electrical Connections:

- Type 1, Leadwire
- Type 2, Cable
- Type 3, Liquid-Tight Cable (Type 22 Mounting Only)

3. Float Types:

- PTFE
- PVDF

4. Electrical Specifications:

- | | |
|--|--|
| A. <input type="checkbox"/> Group I Wiring | <input type="checkbox"/> Group II Wiring |
| B. <input type="checkbox"/> 10 VA | <input type="checkbox"/> 20 VA |
| <input type="checkbox"/> 50 VA | <input type="checkbox"/> 100 VA |

5. Actuation Level Dimensions:

Actuation Level	Distance to Actuation Level – Inches*	SPST Switch Operation** (Check Type)	
		N.O.	N.C.
L4			
L3			
L2			
L1***			

* Measured from inner surface of mounting.
 ** Switch position is "normal" with unit dry (tank empty).
 *** L1 is the distance to the lowest actuation level with mounting "up," and is the distance to the highest actuation level with mounting "down."

B. Length Overall _____ inches

Lead Wire Length:
 24" Other: _____ inches

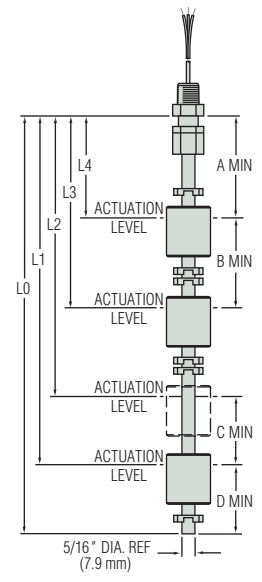

Please contact GEMS Sensors Inc. for any configuration or special requirements not covered on this form. **800-378-1600**

Quote: \$ _____ Date Quoted: ____/____/____

Additional minimum charges may apply on special orders.



Gems Sensors & Controls
 One Cowles Road
 Plainville, CT
 06062-1198
 tel 860.747.3000
 fax 860.747.4244
www.gemssensors.com

LS-350 Series

Combination Siphon and Level Sensor

- ▶ Multi-Level Switch Options
- ▶ Up to 4 Actuation Points
- ▶ Integral Siphon or Fill Tube
- ▶ Customized Mountings
- ▶ Custom Configurable

Save valuable space and costly installation/maintenance time with these highly customizable sensors. LS-350 units combine a siphon tube and up to four liquid level sensors as a single component. The complete unit installs through a single opening in the fluid container.

Simple and clean — a single component that enables remote monitoring of a tank's fluid content while allowing access for container filling and draining. These units are custom configured to fit the container of your choice, with a wide range of mountings, fluid and electrical connectors, materials and lengths.

Typical Applications

- Immuno-Chemistry/Cytology
- Hematology
- Automated Urine Analysis
- Laboratory Automation

Specifications

Materials	
Stem and Mounting	Polysulfone or Noryl®
Floats	Polypropylene or Buna N
Gasket	Buna N
Operating Temperature	
Buna N Float	221°F (105°C) Max.
Polypropylene Float	210°F (99°C) Max.
Switch	
Length	15" (380 mm) Max., Longer units available on request
Mounting Attitude	±30° from vertical
Actuation Level Points	6 Max.

Operating Principle

The LS-350 Series provides two functions: liquid level monitoring and fluid fill or extraction access. The latter function is accomplished with an integrated siphon tube that runs parallel to the float sensor stem and through the top mounting; it is commonly topped with a barb (or customer specified) fitting for the connection of flexible tubing. Fluid level sensing is accomplished with magnetic reed switch technology. One or more floats encircling a stationary stem are equipped with powerful, permanent magnets. As a float rises or lowers with liquid level, the magnetic field generated from within the float actuates a hermetically sealed magnetic reed switch mounted inside the stem. The switch actuation may be used for alarm, solenoid, pump or other fluid control operations.

ORDER IT!
 Ordering is Easy! See Page B-13.
 Easy online ordering too!

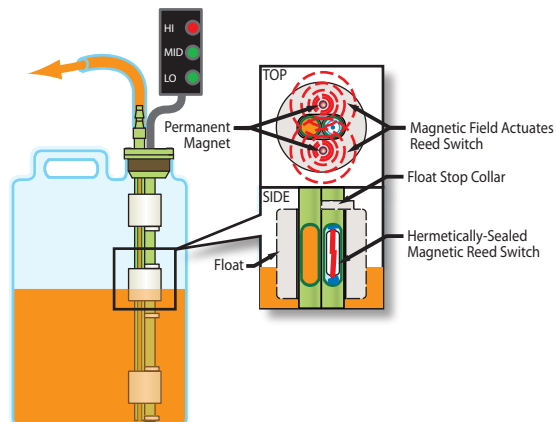
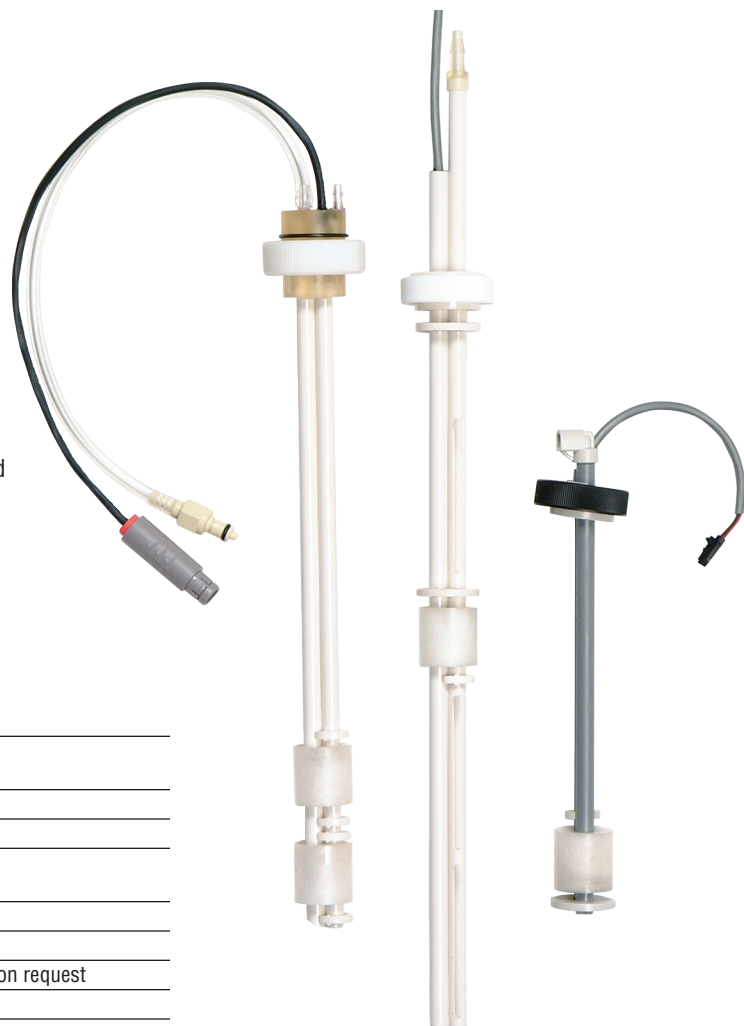

LEVEL SWITCHES - MULTI POINT

1. Mounting Types

Each mounting type can be configured with stem lengths (L_0) and as indicated below.

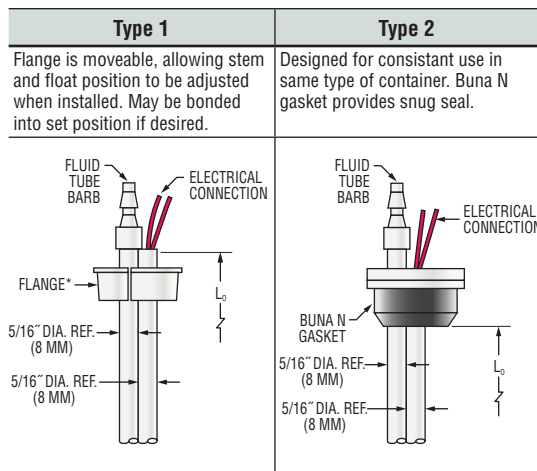

	Type 1	Type 2
Mounting Hole Dia.	1.20"/1.25" (30.5 mm/31.75 mm)	1.31"/1.32" (33.3 mm/33.5 mm)
Stem, Mounting and Collar Material	Polysulfone	Polysulfone with Buna N Gasket
Pressure Rating (mounting)	Atmosphere (Not recommended for pressurized applications)	
Fluid Barb	Compatible 3/16" I.D. Hose (Options available)	
Max Length (L_0)	15 inches (38 cm) \pm 1/16" (2 mm)	
Mounting Position	Vertical \pm 30° Inclination	
Mounting Compatibility	Cubitainer® Style Opening	Tank Wall Thickness 1/32"~1/8"

* Orientation of slot in flange is not critical.

2. Float Types

A single float type is used for all actuation points.

	Buna N	Polypropylene
Part Number	128642	130893
Liquid Suitability	Oil-Based	Water-Based
Min. Media Specific Gravity	0.75	0.98
Operating Temperature	Oil: -40°F to +221°F (-40°C to +105°C) Water: to 180°F (82°C)	-40°F to +210°F (-40°C to +99°C)

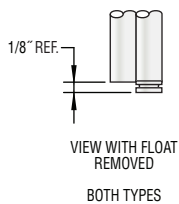

3. Electrical Specifications

Typically, one float is required for each point at which you need a switch action to occur. The number of actuation levels available depends on the Group Type Wiring selected; see below.

Group I Wiring: 1 to 4 Actuation Levels.

Group II Wiring: 1 or 2 Actuation Levels.

Switch (SPST, N.O. or N.C.): 10/20/50/100 VA.

Notes:

1. Other wiring options available. Consult factory.
2. Consult Factory for load information.

4. Wiring Group

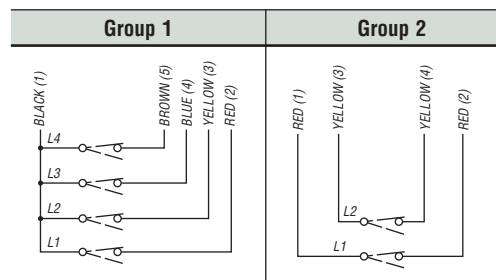

5. Electrical Connections

Type 1: Lead Wires, 24" to 26" (610 mm, Min.)

Type 2: Cable, 24" to 26" (610 mm, Min.)

6. Actuation Level Dimensions

Type 1

Actuation Levels*--Typical

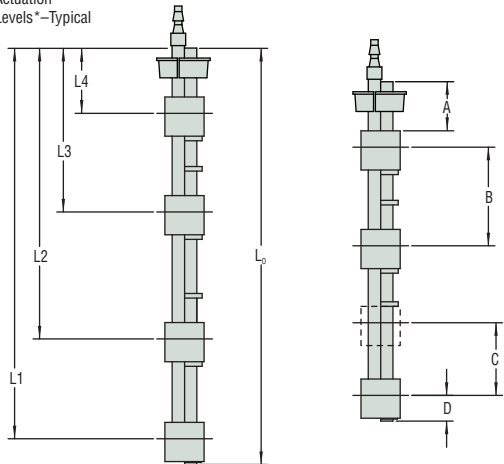

Type 2

Actuation Levels*--Typical

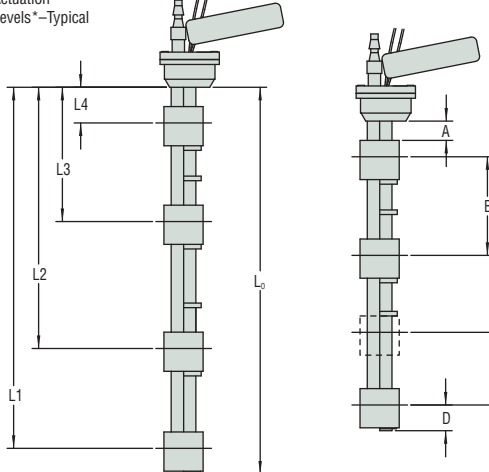

* Actuation level distances and L_0 (overall unit length) are measured from inner surfaces of mounting plug or flange. See mounting types on page 1 for L_0 reference point.

** Length Overall (L_0) = L_1 + Dimension D. See Mounting Types for Maximum Length values.

Switch actuation levels are determined following the guidelines below.

A = Minimum distance to highest actuation level.

B = Minimum distance between actuation levels.

C = Minimum distance between two actuation levels with one float (Note: One float for two levels can be used only when low level is N.C. dry and high level is N.O. dry).

D = Minimum distance from end of unit to lowest level.

Float Type	Dimensions				
	A		B	C	D
	Type 1 Mount	Type 2 Mount			
Buna N	3/4" (19 mm), Min.	3/4" (19 mm)	1-3/4" (45 mm)	1/8" (3 mm)	15/16" (24 mm)
Polysulfone	1/2" (13 mm), Min.	1/2" (13 mm)	1-3/4" (45 mm)	Minimum	1-3/16" (30 mm)

Notes:

1. Actuation levels are calibrated on ascending fluid level with water, specific gravity 1.0, as the calibrating fluid, unless otherwise specified.
2. Tolerance on actuation levels is $\pm 1/8"$ (3 mm).

 <p>Photocopy This Form Use one form for each product type you are selecting. <small>This form may also be completed online at gemssensors.com for RFQ.</small></p>	This is a <input type="checkbox"/> Request for a Quote <input type="checkbox"/> Order P.O.# _____ Quantity Needed _____ Date Required ____/____/____ Shipping Method: _____ Partial Accepted: <input type="checkbox"/> Yes <input type="checkbox"/> No	Name _____ Company _____ Street _____ City _____ State ____ Zip _____ Phone (____) _____ Fax (____) _____
---	--	--

LS-350 Engineered Plastics Custom Length with Siphon Tube Float Type Level Switch Check List

Application Environmental Conditions

This information is essential to the accurate and proper operation of your GEMS configurable sensor. Please complete fully and accurately before ordering.

- | | |
|--|--|
| <p>1. Liquid Media: _____</p> <p>2. Pressure: Minimum _____ <input type="checkbox"/> psig <input type="checkbox"/> bar Maximum _____</p> <p>3. Temperature: Minimum _____ <input type="checkbox"/> °F <input type="checkbox"/> °C Maximum _____ <input type="checkbox"/> °F <input type="checkbox"/> °C</p> <p>4. Specific Gravity: Minimum _____ Maximum _____</p> | <p>5. Viscosity: _____ SSU</p> <p>6. Tank Material: _____</p> <p>Tank Depth: _____</p> <p>7. Unit is Mounted In: <input type="checkbox"/> T – Top Mounted <input type="checkbox"/> B – Bottom Mounted</p> |
|--|--|

1. Mounting Type:

- Type 1 (Standard)
 Type 2

2. Float Type:

- Buna-N – P/N 128462
 Solid Foamed Polypropylene – P/N 130893 (Standard)

3. Electrical Rating:

- 010 – SPST, 10VA 020 – SPST, 20VA
 050 – SPST, 50VA 100 – SPST, 100VA

4. Wiring Group:

- Group 1 – Common Return
 Group 2 – Independent Return

5. Electrical Connections:

<input checked="" type="checkbox"/>	Type	Description
1		Lead Wires, 24" to 26" (610mm, Min.)
2		Cable, 24" to 26" (610mm, Min)

6. Switch Actuation Level:

Actuation Level	Distance to Actuation Level* <input type="checkbox"/> Inches <input type="checkbox"/> Millimeters	SPST Switch Operation** (Check Type)	
		N.O.	N.C.
L4			
L3			
L2			
L1***			

* Measured from inner surface of mounting plug or flange. See mounting types on page B-11.
 ** Switch position is "normal" with unit dry (tank empty).
 *** L1 is the distance to the lowest actuation level with mounting "up," and is the distance to the highest actuation level with mounting "down."

B. Length Overall _____ Inches Millimeters

7. Barb Fitting:

- 3/16" (Standard)
 Other _____

Please contact GEMS Sensors Inc. for any configuration or special requirements not covered on this form. **800-378-1600**

Quote \$ _____ Date Quoted ____/____/____



Gems Sensors & Controls
 One Cowles Road
 Plainville, CT
 06062-1198

tel 860.747.3000
 fax 860.747.4244
 www.gemssensors.com

ORDER IT!

Small Size – Alloys

LS-700 Series Combines Durability of Metal With a Compact Design for Restricted Spaces

- ▶ Stainless Steel or Brass Mountings and Stems
- ▶ 1 to 5 Actuation Levels
- ▶ Lengths to 48 inches

These compact units feature the rugged durability of stainless steel or brass construction in a lightweight package. Ideal for tanks less than 4 feet.

LS-700 Series switches are exceptionally versatile because of the many useful options available. Described briefly below, these options can extend the functionality of your GEMS LS-700 Series custom switch.

Temperature Sensing

To save space and simplify wiring, GEMS can incorporate a temperature sensor in the end of the float stem on any model type LS-700.

Two sensor types are available: Transducers for continuous output, and Thermostats for switch actuation. See Page B-25 for details.



Solid-State Relays

Control motors, pumps, valves and other “load” devices with GEMS Solid-State Relays. Intrinsically-safe relays and barriers allow safe operation of level switches in hazardous areas. See Section I for details.

Factory Mutual Approved Explosion Proof

LS-700-EP Series offers 1 to 5 actuation levels with lengths to 48” for use in hazardous locations. Call Gems factory for details.



1. Mounting Types

Each mounting type can be configured with stem lengths (L_0) and float material indicated in this table.

Note: Sanitary flange mountings are also available, but not shown. Please contact factory.



Type 1 1/8" NPT	Type 2 3/4" NPT ¹	Type 3 1" NPT ¹	Type 4 3-5/8" Dia. Flange

Stem and Mounting Material	Brass or 316 Stainless Steel	
Max Length	48 inches (121.9 cm) – 21" Max On Bent Stem Versions (Consult Factory)	
Mounting Position	Vertical ± 30° Inclination	
Float Stops³	Brass Units: Beryllium Copper Grip Rings; Stainless Steel Units: S.S. ARMCO PH-15-7MO Grip Rings	
Pressure Rating, PSI, Max.⁴	See Float Value on Following Page	50

Notes: 1. Mounting Types 2, 3 & 7 are available with a 1/2" MNPT conduit adaptor. This option can be selected on the checklist.

2. Mounting Type 7 is not U.L. Approved.

3. In some instances, concentrations of chlorine and other corrosive compounds in the media require the use of collar type float stops. Consult factory for details.

4. Mounting only. Maximum pressure rating for complete unit will be the lower of this pressure or the selected float pressure (see Float Types, on next page).

Mounting Options and Float Selection on following pages.

Optional Mountings

Please contact Gems Sensors about these mountings or other requirements not seen here.

Bent Stem (LS-77700)

Used when tank top or bottom is inaccessible.

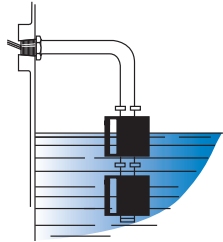

Integral Receptacle

2-5 Pin miniature receptacle for mounting

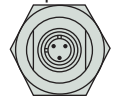

Type 2 or Type 3; eliminates splicing and eases connections.



Conduit Adapter

A 1/2" MNPT conduit is available for Mounting Type 2 & 3. Select from list of options on the Check List.

2. Float Types

A single float type is selected for use at all actuation points.

Float Materials	Buna N		PTFE – Spring Biased	Polypropylene
Compatible Mounting Types	1, 2, 3, 4, 5, 6, 7	1, 3, 4, 5, 6, 7	1, 2, 3, 4, 5, 6, 7	1, 3, 4, 5, 6, 7
Float Dimensions				
Part Number	187553	39049	133764	145730
Operating Temperature	Water: to 180°F (82.2°C) Oil: -40°F to +300°F (-40°C to 149°C)		-40°F to +300°F (-40°C to +149°C)	-40°F to +225°F (-40°C to +107°C)
Pressure, PSI, Max.	300*		1000*	50 PSI @ 70°F*
Min. Liquid Specific Gravity	0.70	0.50	0.65	0.60

*De-rated with increasing temperature above 70°F (21°C).

3. Number of Actuation Levels and Electrical Specifications

Typically, one float is required for each point at which you need a switch action to occur. The number of actuation levels available depends on the Group Type Wiring selected; see below.

Group I Wiring: 1 to 5 Actuation Levels.

Group II Wiring: 1 to 3 Actuation Levels.

Switch (SPST, N.O. or N.C.): 20/100 VA.

Lead Wires: #22 AWG, 24" L., PTFE.

Approvals: LS-700 Series switches are U.L. Recognized – File No. E45168; CSA Listed – 30200.

Typical Wiring Diagrams

For clarity, only two actuation levels are shown in each group diagram.

GROUP I SPST

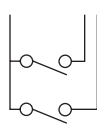

GROUP II SPST

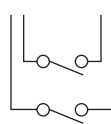

Wiring Color Code

Tinted area designates U.L. Recognized wiring configurations.

SPST Switches			
Wiring	Group I	Group II	
Common Wire	Black	None	
	NO/NC	SW Com.	NO/NC
L1	Red	Red	Red
L2	Yellow	Yellow	Yellow
L3	Blue	Blue	Blue
L4	Brown		
L5	Orange		

Notes:

- Units with 100 VA switches are not U.L. Recognized or CSA Listed.
- See "Electrical Data" on Page X-5.

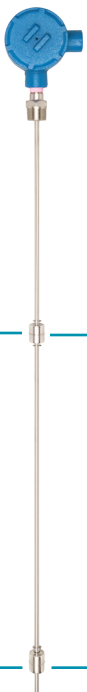

Factory Mutual Approved Explosion-Proof

For Hazardous areas give Gems a call and ask about the LS-700-EP Series. These custom-length sensors provide up to 5 actuation levels, with lengths up to 48". Multiple mounting, float and material options. **800-378-1600**



316 Stainless Steel**				
1, 4, 6	1, 3, 4, 5, 6, 7	1, 4, 5, 6, 7	1, 2, 3, 4, 5, 6, 7	1, 2, 3, 4, 5, 6, 7
60241	141750	156900	136550	158369
-40°F to +300°F (-40°C to +149°C)**				
100	275	600	400	150
0.70	0.90	0.90	1.10	.90

** 316 Stainless Steel floats are available with ceramic potting that allows temperatures to 400°F (204°C); contact factory for these high-temperature applications.

4. Actuation Level Dimensions

Actuation Levels*—Typical

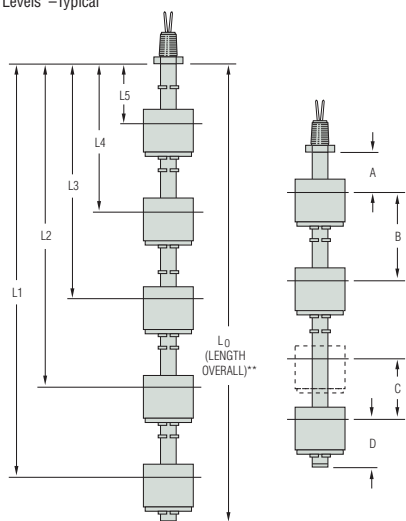

* Actuation level distances and L₀ (overall unit length) are measured from inner surfaces of mounting plug or flange.

** Length Overall (L₀) = L₁ + Dimension D. See Mounting Types for Maximum Length values.

Switch actuation levels are determined following the guidelines below.

A = Minimum distance to highest actuation level.

B = Minimum distance between actuation levels.

C = Minimum distance between two actuation levels with one float (Note: One float for two levels can be used only when low level is N.C. dry and high level is N.O. dry).

D = Minimum distance from end of unit to lowest level.

Float Part Number	Dimensions			
	A	B	C	D
39049	7/8" (22.2 mm)	1-3/4" (44.4 mm)	1/8" (3.2 mm) Min.	3/4" (19.1 mm)
60241	3/4" (19.1 mm)	1-13/16" (46.0 mm)		15/16" (23.8 mm)
133764	15/16" (23.8 mm)	1-7/8" (47.6 mm)		7/8" (22.2 mm), N.O. 1-3/16" (30.2 mm), N.C.
136550	9/16" (14.3 mm)	2-7/16" (61.9 mm)		1-3/4" (44.4 mm)
141750	13/16" (20.6 mm)	2" (50.8 mm)		1-1/8" (28.6 mm)
145730	7/8" (22.2 mm)	1-7/16" (36.5 mm)		7/8" (22.2 mm)
156900	3/4" (19.1 mm)	1-7/8" (47.6 mm)		1-1/16" (27.0 mm)
158369	13/16" (20.6 mm)	2-7/16" (61.9 mm)		1-7/16" (36.5 mm).
187553	11/16" (17.5 mm)	1-7/16" (36.5 mm)		7/8" (22 mm)

Notes:

1. A, B and D dimensions based on a liquid specific gravity of 1.0.
2. Tolerance on actuation levels is ±1/8" (3.2 mm).
3. For bent stem versions, please request drawing LS-77700.

 <p>Photocopy This Form Use one form for each product type you are selecting. This form may also be completed online at gemssensors.com for RFQ.</p>	This is a <input type="checkbox"/> Request for a Quote <input type="checkbox"/> Order P.O.# _____	Name _____ Company _____ Street _____ City _____ State _____ Zip _____ Phone (____) _____ Fax (____) _____
	Quantity Needed _____ Date Required ____/____/____ Shipping Method: _____ Partial Accepted: <input type="checkbox"/> Yes <input type="checkbox"/> No	

LS-700 Types Custom Length Float Type Level Switches

Application Environmental Conditions

This information is essential to the accurate and proper operation of your GEMS configurable sensors. Please complete fully and accurately.

- Liquid Media:** _____
- Pressure:** Minimum _____ psig Maximum _____
- Temperature:** Minimum _____ °F Maximum _____
- Specific Gravity:** Minimum _____ Maximum _____
- Viscosity:** _____ SSU
- Tank Material:** _____
Tank Depth: _____
- Unit is Mounted In:** Tank Top Tank Bottom

1. Series Type:

- LS-700 TH-700 (Thermostat Equipped)
 TM-700 (Thermistor Equipped)

2. Mounting Type and Materials:

- A. Mounting Type:**
 Type 1 Type 2 Type 3 Type 4
 Type 5 Type 6 Type 7

B. Mount and Stem Material:

- Brass
 316 Stainless Steel

3. Float Part Number: _____

Matching floats will be used at each actuation level specified.

4. Switch Type and Rating:

- A.** Group I Group II
B. SPST
C. 20 VA 100 VA
 Please indicate if using microprocessor/PLC load: Yes No

5. Switch Actuation Level

Actuation Level	Distance to Actuation Level – Inches*	SPST Switch Operation** (Check Type)	
		N.O.	N.C.
L5			
L4			
L3			
L2			
L1***			

* Measured from inner surface of mounting plug or flange.
 ** Switch position is "normal" with unit dry (tank empty).
 *** L1 is the distance to the lowest actuation level with mounting "up," and is the distance to the highest actuation level with mounting "down."

B. Length Overall (L₀) _____ inches.

6. Lead Wire Length:

- 12" 24" Other: _____ inches.

7. Options:

- Temperature Switch Settings (°F): 100 125 150
 175 200

On rising temperature, switch... Opens Closes

- Slosh Shield Collars
 1/2" NPT Conduit Connection (available for Types 2, 3 & 7)

J-box Electrical Connection

- Explosion Proof Type (FM/CSA) NEMA 4 Type

Please contact GEMS Sensors Inc. for any configuration or special requirements not covered on this form. **800-378-1600**

Quote: \$ _____ Date Quoted: ____/____/____

Additional minimum charges may apply on special orders.



Gems Sensors & Controls
 One Cowles Road
 Plainville, CT
 06062-1198

tel 860.747.3000
 fax 860.747.4244
www.gemssensors.com

Large Size – Engineered Plastics

LS-800PVC Series – Our Most Economical Large Size Unit

- ▶ NSF Approved All-PVC Wetted Parts Available
- ▶ 1 to 7 Actuation Levels
- ▶ Lengths to 60 inches

Inexpensive, all-PVC LS-800PVC Series switches bring reliable level sensing to corrosive liquids. These durable, yet economical, switches use the same high-quality, dependable reed switches found in GEMS' most expensive models. NSF-approved wetted parts make the LS-800PVC suitable for potable water applications.



ORDER IT!
Ordering is Easy! See Page B-26.
Easy online ordering too!

1. Mounting Types

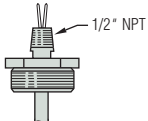
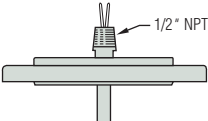
	Type 1 1/2" NPT	Type 3 2" NPT	Type 4 3", 150# Flange
			
Mounting and All Wetted Parts	PVC		
Operating Temperatures	0°F to 125°F (-17.8°C to 51.7°C)		
Pressure, PSI, Max.	15 @ 70°F (21°C)		
Max. Length (Lo)	60 inches (152.4cm)		
Mounting Position	Vertical ±30° Inclination		

2. Float Type

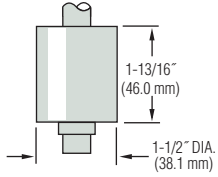
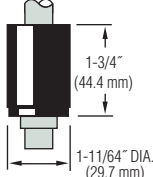
Float Material	PVC*	Buna N
Float Dimensions		
Float Part Number	16306	142251
Min. Liquid Specific Gravity	0.85	0.80

*Select for potable water applications.

LS-800PVC Series – Continued

3. Number of Actuation Levels and Electrical Specifications

Typically, one float is required for each point at which you need a switch action to occur. The number of actuation levels available depends on type of wiring selected. See below.

Group I Wiring: 1 to 7 Actuation Levels

Group II Wiring: 1 to 4 Actuation Levels

Group III Wiring: 1 to 3 Actuation Levels

Group IV Wiring: 1 to 2 Actuation Levels

Switch (N.O. or N.C.):

SPST: 20 VA or 100 VA

SPDT: 20 VA

Lead Wires: #22 AWG, 24" L., PVC

Typical Wiring Diagrams

For clarity, only two actuation levels are shown in each group diagram.

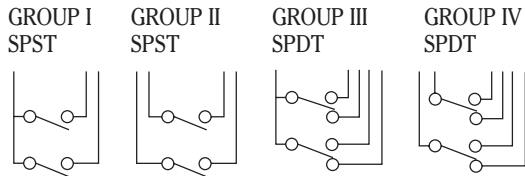

Wiring Color Code

Wiring	SPST Switches			SPDT Switches 20 VA				
	Group I	Group II		Group III		Group IV		
Com. Wire	Black	None		Black		None		
	NO/NC	SW. Com.	NO/NC	NO	NC	SW. Com.	NO	NC
L1	Red	Red	Red	Red	Wh/Red	Red	Wh/Red	Wh/Blk/Red
L2	Yellow	Yellow	Yellow	Yellow	Wh/Yel	Yellow	Wh/Yel	Wh/Blk/Yel
L3	Blue	Blue	Blue	Blue	Wh/Blue			
L4	Brown	Brown	Brown					
L5	Orange							
L6	Gray							
L7	White							

Notes: See "Electrical Data" on Page X-5 for more information.

4. Actuation Level Dimensions

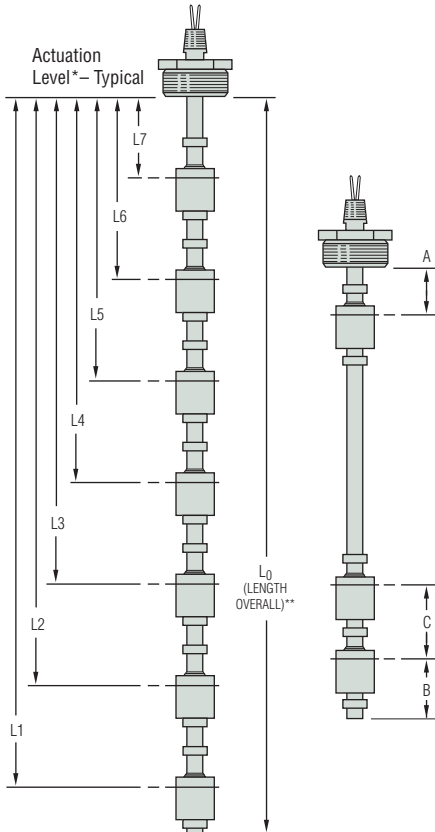

Switch actuation levels are determined following the guidelines below.

A = 1-1/2" (38.1 mm) Minimum distance to highest actuation level.

B = 2" (50.8 mm) Minimum distance from end of unit to lowest actuation level.

C = 3" (76.2 mm) Minimum distance between actuation levels.

Notes:

1. Actuation levels are calibrated on descending fluid level, with water as the calibrating fluid, unless otherwise specified.
2. A and B dimensions based on a top mounted unit.
3. Float stops are permanently cemented in place.
4. Tolerance on actuation levels is $\pm 1/8"$ (3.2 mm).
5. Dimensions based on a liquid specific gravity 1.0.

* Actuation level distances and L_0 (overall unit length) are measured from inner surfaces of mounting plug or flange.

** Length Overall (L_0) = L_1 + Dimension B. See Mounting Types for Maximum Length values.

Large Size – Engineered Plastics

LSP-800 Series – Features Inert Materials for Corrosive Liquids

- ▶ All-Plastic Wetted Parts - PVC, Polypropylene or PVDF
- ▶ 1 to 6 Actuation Levels
- ▶ Lengths to 70 inches

Specifically designed for corrosive liquids and vapors. Three standard model types in a choice of materials offer broad chemical compatibility.

1. Mounting Types

Each mounting type can be configured with stem lengths (L_0) and materials indicated in the table below. Floats and float stop collars are of same material specified for mounting.



CE

ORDER IT!
 Ordering is Easy! See Page B-26.
 Easy online ordering too!

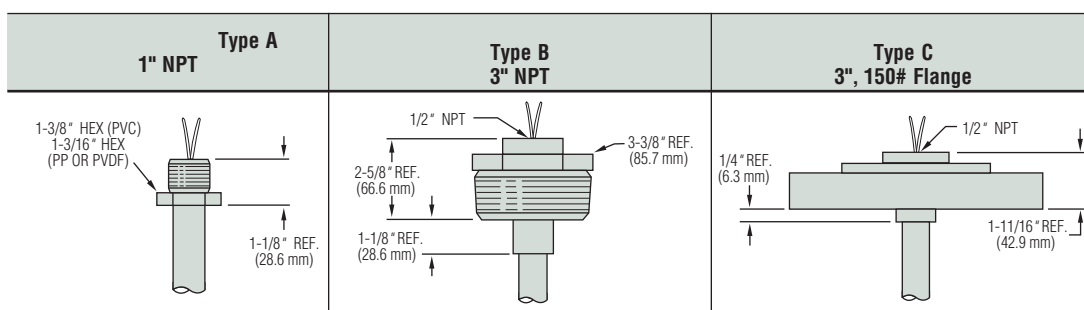

Stem, Mounting, Float and Collar Material	PVC, Polypropylene or PVDF
Max. Length (L_0)	70 inches (177.8 cm)
Mounting Position	Vertical $\pm 30^\circ$ Inclination

2. Float Types

Float Material	PVC	Polypropylene	PVDF
Float Dimensions			
Operating Temperature and Pressure	See Ratings Chart at top of following page		
Min. Liquid Specific Gravity	0.60	0.40	0.75

Note: Floats are always supplied in same material as specified for mounting.

LEVEL SWITCHES – MULTI POINT

LSP-800 Series – Continued

Temperature and Pressure Ratings Chart

Maximum Pressure vs. Temperature

LSP-800 Material	Operating Temperature							
	0°F (-17.7°C)	70°F (21.1°C)	100°F (37.7°C)	125°F (51.7°C)	140°F (60.0°C)	170°F (76.6°C)	200°F (93.3°C)	210°F (98.8°C)
PVC	50 PSI (3.4 bar)	50 PSI (3.4 bar)	35 PSI (2.4 bar)	20 PSI (1.4 bar)	10 PSI (0.68 bar)	X	X	X
Polypropylene	50 PSI (3.4 bar)	50 PSI (3.4 bar)	40 PSI (2.7 bar)	35 PSI (2.4 bar)	30 PSI (2.0 bar)	25 PSI (1.7 bar)	X	X
PVDF	50 PSI (3.4 bar)	50 PSI (3.4 bar)	45 PSI (3.1 bar)	40 PSI (2.7 bar)	35 PSI (2.4 bar)	30 PSI (2.0 bar)	25 PSI (1.7 bar)	25 PSI (1.7 bar)

3. Electrical Specifications

Switch (N.O. or N.C.):

SPST: 20 VA or 100 VA

SPDT: 20 VA

Lead Wires: #22 AWG, 24" L., Polymeric

Typical Wiring Diagrams

For clarity, only two actuation levels are shown in each group diagram.

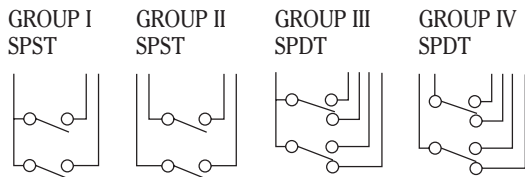

Wiring Color Code

Wiring	SPST Switches			SPDT Switches 20 VA				
	Group I	Group II		Group III		Group IV		
Com. Wire	Black	None		Black		None		
	NO/NC	SW. Com.	NO/NC	NO	NC	SW. Com.	NO	NC
L1	Red	Red	Red	Red	Wh/Red	Red	Wh/Red	Wh/Blk/Red
L2	Yellow	Yellow	Yellow	Yellow	Wh/Yel	Yellow	Wh/Yel	Wh/Blk/Yel
L3	Blue	Blue	Blue	Blue	Wh/Blue	Blue	Wh/Blu	Wh/Blk/Blu
L4	Brown	Brown	Brown	Brown	Wh/Brn	Brown	Wh/Brn	Wh/Blk/Brn
L5	Orange	Orange	Orange	Orange	Wh/Orn	Orange	Wh/Orn	Wh/Blk/Orn
L6	Gray	Gray	Gray	Gray	Wh/Gra	Gray	Wh/Gra	Wh/Blk/Gra

Notes: See "Electrical Data" on Page X-5 for more information.

4. Actuation Level Dimensions

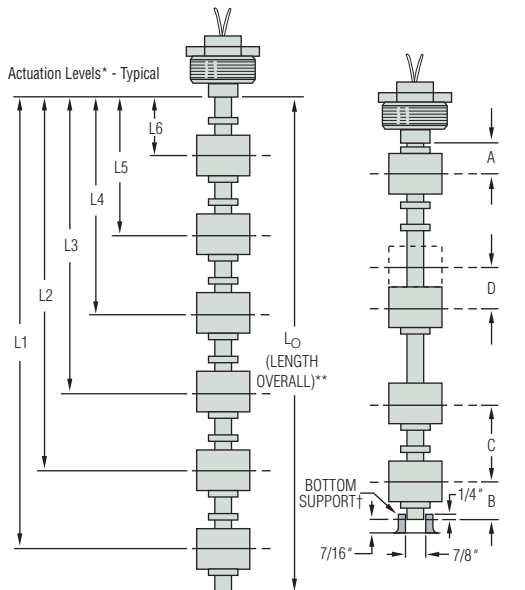

Switch actuation levels are determined following the guidelines below.

- A = 2-1/16" (52.4 mm) ±1/16" minimum distance to centerline of float (ref. mounting).
- B = 2-11/16" (68.3 mm) ±1/16" minimum distance to centerline of float (ref. stem end).
- C = 3-1/2" (88.9 mm) minimum distance between actuation levels.
- D = Distance between actuation levels using one float.
 Minimum = 1/4" (6.3 mm)
 Maximum = 3-1/2" (88.9 mm)

Notes:

1. The centerline of the float is used as a standard reference for actuating the switches.
2. All levels are set on descending float travel with overtravel = 1/4" (6.3mm) ±1/8" (3.2mm).
 Overtravel on Ascending = 1/8" (3.2mm) min.
3. Tolerance on all actuation levels is ±1/8" (3.2 mm) Ref.

* Actuation level distances and L₀ (overall unit length) are measured from inner surfaces of mounting plug or flange.

** Length Overall L₀ = L₁ + Dimension B. See Mounting Types for Maximum Length values.

† Bottom support recommended for units longer than 36 inches, or in applications having turbulent conditions.

Large Size – Alloys

LS-800 Series – The General Purpose Workhorse for Water and Oils

- ▶ Stainless Steel or Brass Mountings
- ▶ 1 to 6 Actuation Levels
- ▶ Lengths to over 11 feet (3.4 m)
- ▶ CSA Listed

Rugged construction and multiple options provide the LS-800 Series with exceptional versatility. Longer and more substantial than other metallic models, the LS-800 is capable of supporting larger, more buoyant floats, and is physically stronger for better reliability in contaminated or turbulent media. This series offers SPST or SPDT switches, and a choice of mountings, floats and materials that can be configured for a wide range of applications in water, oils, chemicals and corrosive liquids.

Temperature Sensing

To save space and simplify wiring, GEMS can incorporate a temperature sensor in the end of the float stem on any model type LS-800. Two sensor types are available: Transducers for continuous output, and Thermostats for switch actuation. See Page B-25 for details.



Adjustable Mounting

Allows stem to travel up and down for fine tuning your actuation points. See next page.



LS-800 switches are U.L. Approved for Class I, Division 2, Groups B, C, D hazardous locations

They are also available with FM-approved, explosion-proof junction box for Class I, Division 1, Group D hazardous locations (Type 1 mounting excluded). Units must be specified with stainless steel floats and be assembled completely at GEMS.



1. Mounting Types

Each mounting type can be configured with stem lengths (L_0) and float material indicated in the table below. Mountings are also continued on following page.

Note: Sanitary flange mountings are also available, but not shown. Please contact factory.
Type 1 mounting not FM approved.

	Type 1 1/2" NPT†	Type 2 1-1/4" NPT	Type 3 2" NPT	Type 4 3", 150# Dia. Flange
Stem and Mounting Material	Brass or 316 Stainless Steel			Flange: Carbon Steel or 316 S.S. Stem: 316 S.S.
Max Length (Lo)	36" (91.4 cm)	60" (152.4 cm)	140" (355.6 cm)	
Mounting Position	Vertical ± 30° Inclination			
Float Stops*	Brass Units: Beryllium Copper Grip Rings; Stainless Steel Units: S.S. ARMCO PH-15-7MO Grip Rings			

* Units greater than 72" overall length are supplied with collars with setscrews (made of same material as stem and mounting) in place of float-stop rings. Collars are optional on units less than 72" overall length. Units requiring 316 SS float stops must be special ordered with 316 SS collars instead of grip rings. In some instances, concentration of chlorine and other corrosive compounds in the media require the use of collar type float stops. Consult factory for details.

† Type 1 mounting not FM approved.



ORDER IT!

Ordering is Easy! See Page B-26.
Easy online ordering too!

UL Approved
Explosion-Proof



LEVEL SWITCHES – MULTI POINT

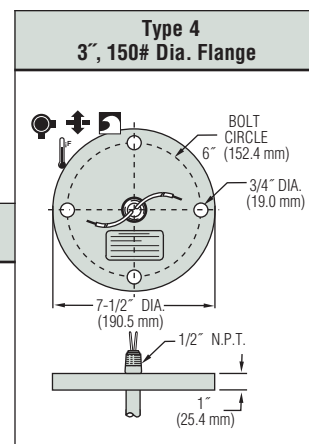

LS-800 Series - Continued

1. Mounting Types - continued

Type 5 External Mounting units are ideal for tanks with limited access to tops or bottoms.

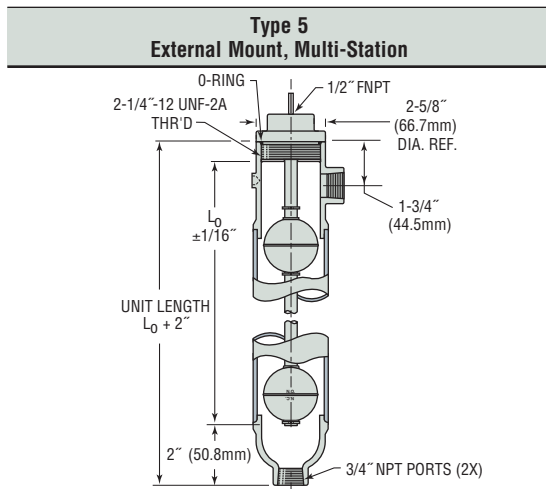

Housing Material	Brass	316 Stainless Steel
Stem and Mounting	Brass	316 Stainless Steel
Port Sizes	3/4" NPT	
Max. Length (Lo)	120" (305 cm)	
Float Stops*	Beryllium Copper	S.S. ARMCO PH-15-7 MO

* Units greater than 72" overall length are supplied with collars with setscrews (made of same material as stem and mounting) in place of float-stop rings. Collars are optional on units less than 72" overall length. Units requiring 316 SS float stops must be special ordered with 316 SS collars instead of grip rings. In some instances, concentration of chlorine and other corrosive compounds in the media require the use of collar type float stops. Consult factory for details.

2. Float Types

A single float type is selected for use at all actuation points. Be sure, by reviewing the table below, that the desired float is compatible with the Mounting Type selected in Step 1.

Float Material	Buna N			316 Stainless Steel		
Compatible Mounting Types	2	1, 3, 4, 5	3, 4, 5 (Units >72")	1, 3, 4, 5 (Units ≤72")	3, 4, 5 (Units >72")	1, 3, 4
Float Dimensions						
Part Number	26032	10558	24864	14569	15666	138935
Operating Temperature	Water: to 180°F (82°C) Oil: -40°F to +230°F (-40°C to +110°C)			-40°F to +300°F (-40°C to +149°C)		
Min. Media Specific Gravity	0.75	0.55	0.55	0.75	0.75	0.80

Pressure Ratings Chart (PSI, Max.)

Mounting Type		Float Part Number						
		26032	10558	24864	14569	15666	138935	
1, 2, 3	4	150				750	300	180
	5	150				750	300	180
4	Brass	100 @ 70°F (21°C)						
	316 S.S.	150		750	300	120		

Review the Compatible Mounting Type row in the "Float Types" table above this matrix for produceable mounting/float combinations. Not all combinations implied by this Pressure Rating Chart are possible or recommended.

LS-800-A Series Adjustable Mounting

Available for LS-800 Series Mounting Types 2, 3 and 4.

Special cinch-nut on mounting allows stem to travel up or down for fine tuning the actuation points. The extent of adjustment depends on unit length and distance from mounting to highest float stop. When ordering, specify "LS-800-A" as Series Type.

Note: Maximum overall length is limited to 72" with this option.

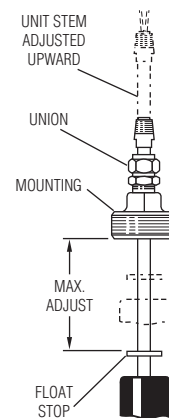

Intrinsically-Safe Relays

Using Gems SAFE-PAK® relays and barriers, these switches provide automatic refills/pumpdown and are intrinsically-safe without explosion-proof housing and piping.



See Section L

3. Electrical Specifications

Switch (N.O. or N.C.):

SPST: 20 VA or 100 VA

SPDT: 20 VA

Lead Wires: #18 AWG, 24" L., Polymeric (except as noted in Wiring Color Code chart at right).

Approvals: LS-800 Series switches are U.L. Recognized – File No. E45168; CSA Listed – File No. 30200

Typical Wiring Diagrams

For clarity, only two actuation levels are shown in each group diagram.

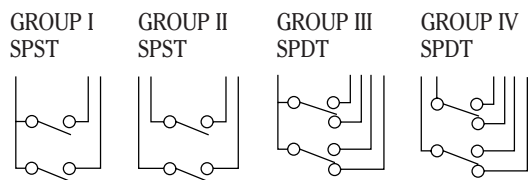

Wiring Color Code

Tinted area designates U.L. Recognized wiring configurations.

Wiring	SPST Switches			SPDT Switches 20 VA				
	Group I	Group II		Group III		Group IV		
Com. Wire	Black	None		Black		None		
	NO/NC	SW. Com.	NO/NC	NO	NC	SW. Com.	NO	NC
L1	Red	Red	Red	Red	Wh/Red	Red	Wh/Red	Wh/Blk/Red
L2	Yellow	Yellow	Yellow	Yellow	Wh/Yel	Yellow	Wh/Yel	Wh/Blk/Yel
L3	Blue	Blue	Blue	Blue	Wh/Blue	Blue	Wh/Blu	Wh/Blk/Blu
L4	Brown	Brown	Brown	Brown	Wh/Brn	Brown	Wh/Brn	Wh/Blk/Brn
L5	Orange	Orange	Orange	Orange	Wh/Orn	Orange	Wh/Orn	Wh/Blk/Orn
L6	Gray	Gray	Gray	Gray	Wh/Gra	Gray	Wh/Gra	Wh/Blk/Gra

Notes:

1. Non-U.L. Recognized units (white areas) use #22 AWG, 24" L., PTFE Lead wires.
2. Units with 100 VA switches are not U.L. Recognized or CSA Listed.
3. See "Electrical Data" on Page X-5 for more information.

4. Actuation Level Dimensions

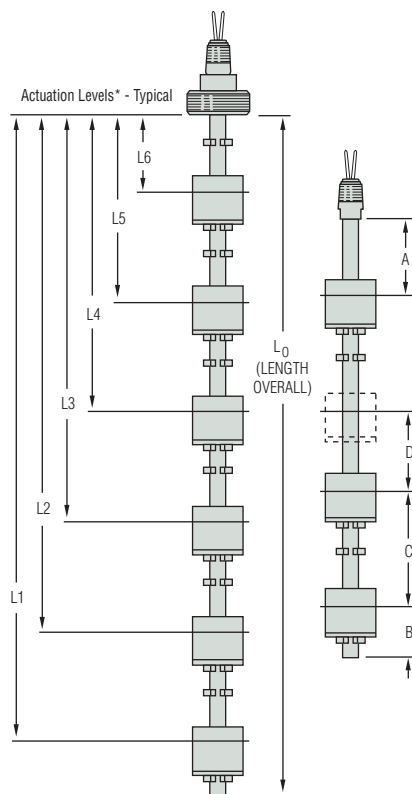

Switch actuation levels are determined following the guidelines below.

All units 72" or less L_0 with Stainless Steel or Buna N floats. Also any unit over 72" L_0 with Buna N floats:

A = 1-1/2" (38.1 mm) minimum distance to highest level (2", Type 5 only).

B = 2" (50.8 mm) minimum distance from end of unit to lowest level.

C = 3" (76.2 mm) minimum distance between levels.

D = 1/4" (6.3 mm) minimum distance between actuation levels (Note: One float for two levels can be used only when low level is N.C. dry and high level is N.O. dry).

Types 1, 3, 4, and 5 units with stainless steel float, Part Number 15666:

A = 1-5/8" (41.3 mm) minimum distance to highest level (2", Type 5 only).

B = 2-1/2" (63.5 mm) minimum distance from end of unit to lowest level.

C = 4" (101.6 mm) minimum distance between level.

D = 1/4" (6.3 mm) minimum distance between actuation levels (Note: One float for two levels can be used only when low level is N.C. dry and high level is N.O. dry).

Notes:

1. A, B and C dimensions based on a liquid specific gravity of 1.0.
2. One float for two levels can be used only when 20VA switch is used.
3. Actuation levels are calibrated on descending fluid level, with water as the calibrating fluid, unless otherwise specified.
4. Tolerance on actuation levels is $\pm 1/8"$ (3.2 mm).
5. TH (Temperature option) makes "B" dimension a minimum of 2.75" (69.8 mm).

* Actuation level distances and L_0 (overall unit length) are measured from inner surfaces of mounting plug or flange.

** Length Overall $L_0 = L_1 + \text{Dimension B}$.

See Mounting Types for Maximum Length values.

Optional Integrated Temperature Sensors

- ▶ Compatible with LS-700 and LS-800 Series Units
- ▶ Thermostat Switches or Thermistor Versions

Advantages of integrated temperature sensors:

- Space Saving.
- Fewer intrusions into the tank.
- Electrical wiring emanates from a single source – eliminate multiple conduits.
- Economical – typically less expensive than separate sensors.

Look for units in this catalog with the temperature sensor icon: 

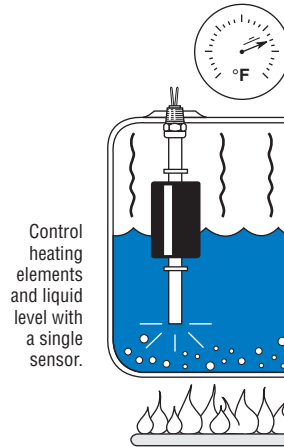

Thermistor for Continuous Indication – TM-800 and TM-700

- Excellent repeatability.

Value: 10,000 ohms @ 77°F (25°C)

Tolerance: ±0.2°C from 32°F to 158°F (0°C to 70°C)

Operating Temperature: 302°F (150°C), Max.

Alpha @ 25°C: -4.39%/°C

Dissipation Constant: 1mW/°C in Still Air;
8mW/°C in Oil Bath.

How to Order

Temperature thermistors are available on LS-700 Series units with up to three actuation levels, and on LS-800 Series units with up to five actuation levels. To have thermistor added, order model TM-800 or TM-700.

Note: This option is not CE Approved.

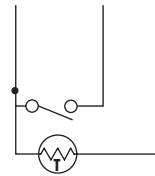

GROUP I

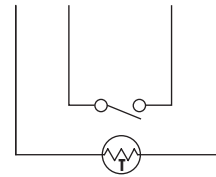

GROUP II

Thermostat for Switch Actuation

- Standard Settings from 100°F to 200°F.
- Open or close switch on increasing temperature.

Use these switches to set off High/Low temperature alarms. Or, combine with GEMS relays to control tank heating and cooling, motor-operated valves, etc.

To designate the thermostat switch option, order model TH-700 or TH-800. Also specify the choice from selections A, B and C below.

- Switch Rating:**
For LS-800 Series: 6A/120V, 4A/240V, 100VA (non-inductive).
For LS-700 Series: 2.6A/120V (inductive).
- Contact Operation on Increasing Temperature:**
“Opens” when Set Point reached or “Closes” when Set Point reached.
- Standard Temperature Set Point (±7.2°F; ±4°C):**
100°F (37.7°C), 125°F (51.6°C), 150°F (65.6°C), 175°F (79.4°C), 200°F (93.3°C)

- Note:
- Other temperature settings and tolerances available; 25 piece minimum order quantity applies. Please call GEMS Sensors Inc. for more information.
 - This option is not CE Approved.

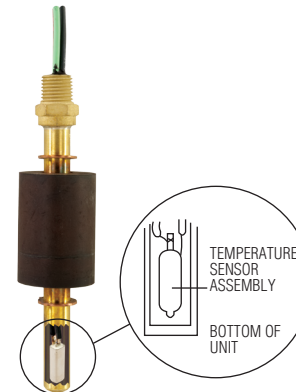

Note: End of unit stem must be submerged a minimum of 2-3/4” for level switch actuation.

Typical Wiring Diagram

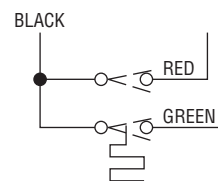

GROUP I

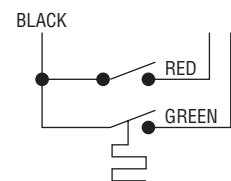

GROUP II

 <p>Photocopy This Form Use one form for each product type you are selecting. <small>This form may also be completed online at gemssensors.com for RFQ.</small></p>	This is a <input type="checkbox"/> Request for a Quote <input type="checkbox"/> Order P.O.# _____ Quantity Needed _____ Date Required ____/____/____ Shipping Method: _____ Partial Accepted: <input type="checkbox"/> Yes <input type="checkbox"/> No	Name _____ Company _____ Street _____ City _____ State ____ Zip _____ Phone (____) _____ Fax (____) _____
--	--	--

LS-800 Types Custom Length Float Type Level Switches

Application Environmental Conditions

This information is essential to the accurate and proper operation of your GEMS configurable sensors. Please complete fully and accurately.

- | | |
|--|---|
| <p>1. Liquid Media: _____</p> <p>2. Pressure: Minimum _____ psig Maximum _____ psig</p> <p>3. Temperature: Minimum _____ °F Maximum _____ °F</p> <p>4. Specific Gravity: Minimum _____ Maximum _____</p> | <p>5. Viscosity: _____ SSU</p> <p>6. Tank Material: _____</p> <p>Tank Depth: _____</p> <p>7. Unit is Mounted In: <input type="checkbox"/> Tank Top <input type="checkbox"/> Tank Bottom</p> |
|--|---|

1. Series (Page No.):

- LS-800PVC (B-18) LSP-800 (B-20) LS-800 (B-22)
 LS-800-Adjustable (B-23)
 TM-800 (B-25. Thermistor Equipped)
 TH-800 (B-25. Thermostat Equipped)

See product page number for available mounting type and materials.

2. Mounting Type:

- Type A Type B Type C
 Type 1 Type 2 Type 3
 Type 4 Type 5

3. Mounting and Stem Material (if choice available):

- Brass Polypropylene
 PVC PVDF
 316 Stainless Steel Carbon Steel (Flanges Only, in association with stainless steel stems.)

4. Mounting Position:

- Tank Top Tank Bottom

5. Float Part Number: _____

Matching floats will be used at each actuation level specified.

6. Switch Type and Rating:

- A.** Group I Group II
 Group III* Group IV*
B. SPST SPDT*
C. 20 VA 100 VA (SPST only)
 Please indicate if using microprocessor/PLC load: Yes No

* Not Available on the TM-800 Series.

Please contact GEMS Sensors Inc. for any configuration or special requirements not covered on this form. **800-378-1600**

Quote: \$ _____ Date Quoted: ____/____/____

Additional minimum charges may apply on special orders.

Visit www.GemsSensors.com for most current information.

7. Switch Actuation Level

Actuation Level	Distance to Actuation Level (Inches) ¹	SPST Switch Operation ² (Check Type)	
		N.O.	N.C.
L6			
L5			
L4			
L3			
L2			
L1 ³			

Notes:

1. Measured from inner surface of mounting plug or flange.
2. Switch position is "normal" with unit dry (tank empty).
3. L1 is the distance to the lowest actuation level with mounting "up," and is the distance to the highest actuation level with mounting "down."
4. Float stops are standard; see B-24 for specifications.

B. Length Overall (L₀) _____ inches (customer supplied support bracket assembly recommended for lengths over 72".)

8. Lead Wire Length:

- 12" 24" Other: _____ inches.

Options:

- Temperature Switch Settings (°F): 100 125 150
 175 200
 On rising temperature, switch... Opens Closes
 Slosh Shield 316 SS (316 SS units only)
 Brass (Brass units only)

J-Box Electrical Connection:

- Explosion Proof Type (FM/CSA)*
 NEMA 4 Type Plastic ABS Type

* Requires stainless steel floats



Gems Sensors & Controls
 One Cowles Road
 Plainville, CT
 06062-1198
 tel 860.747.3000
 fax 860.747.4244
 www.gemssensors.com